

FLOW SOLDER POST CONTACTS  
 (-1, -3, -5, -7, OUTSIDE ROWS ONLY, AS SHOWN)  
 (-9, 1- -1, 1- -3, 1- -5, WITH ALL 3 ROWS FULLY LOADED)

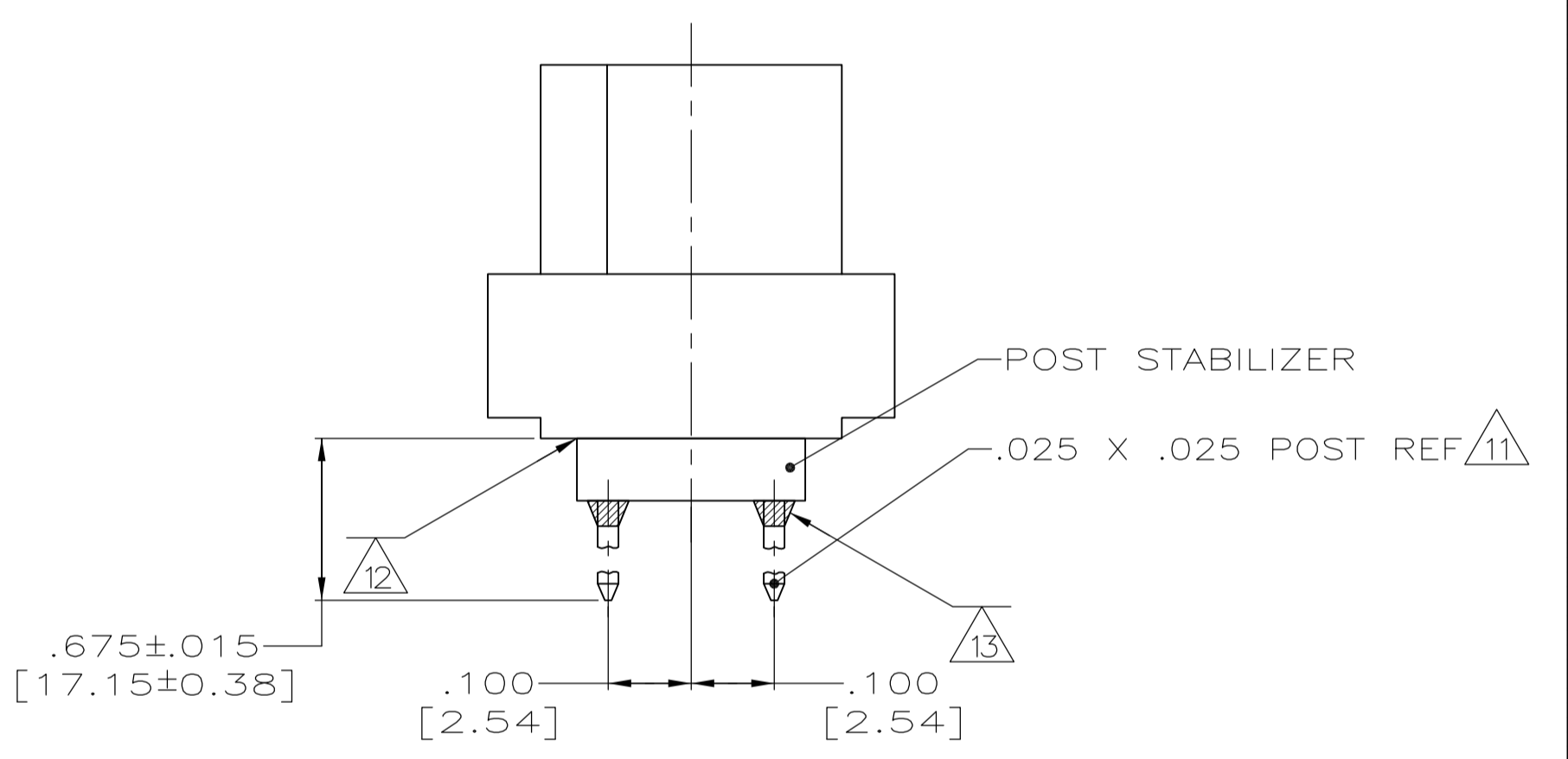

WRAP TYPE POST 3-HIGH CONTACT  
 (-2, -4, -6, -8, OUTSIDE ROWS ONLY)  
 (1- -0, 1- -2, 1- -4, 1- -6, WITH ALL 3 ROWS FULLY LOADED)

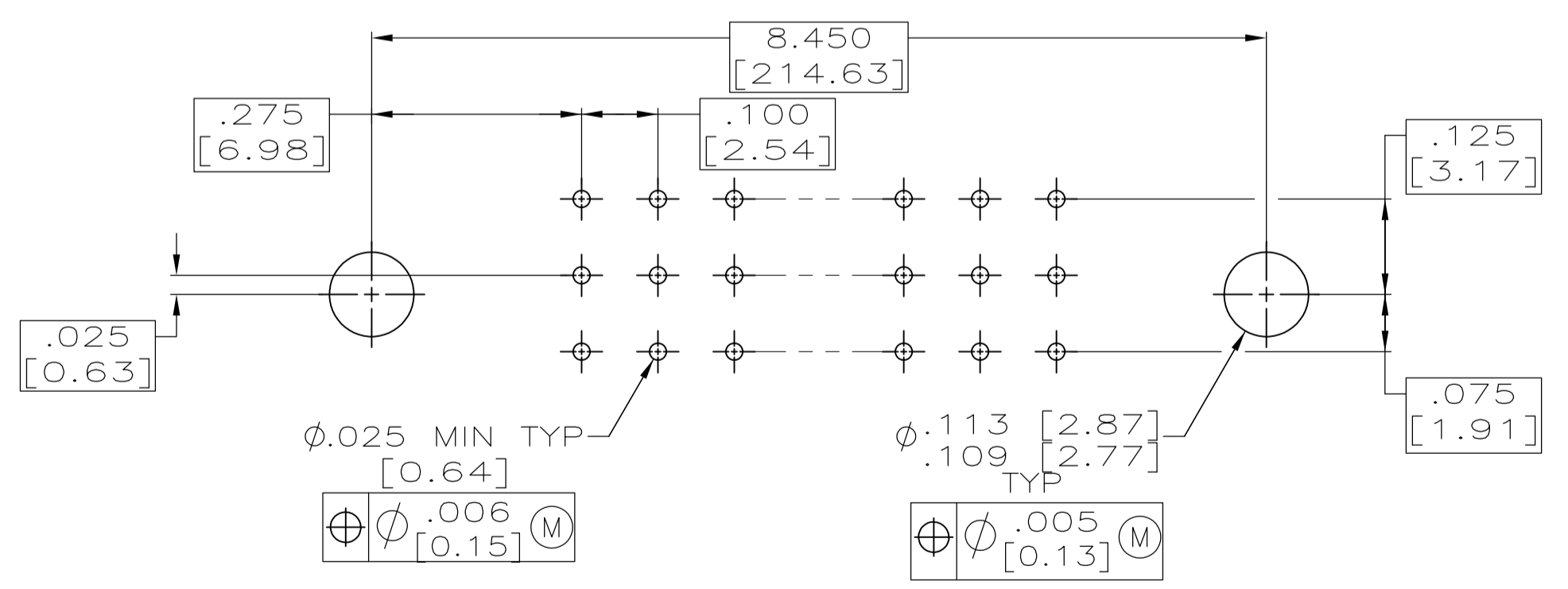

RECOMMENDED P. C. BOARD LAYOUT  
 FLOW SOLDER TYPE

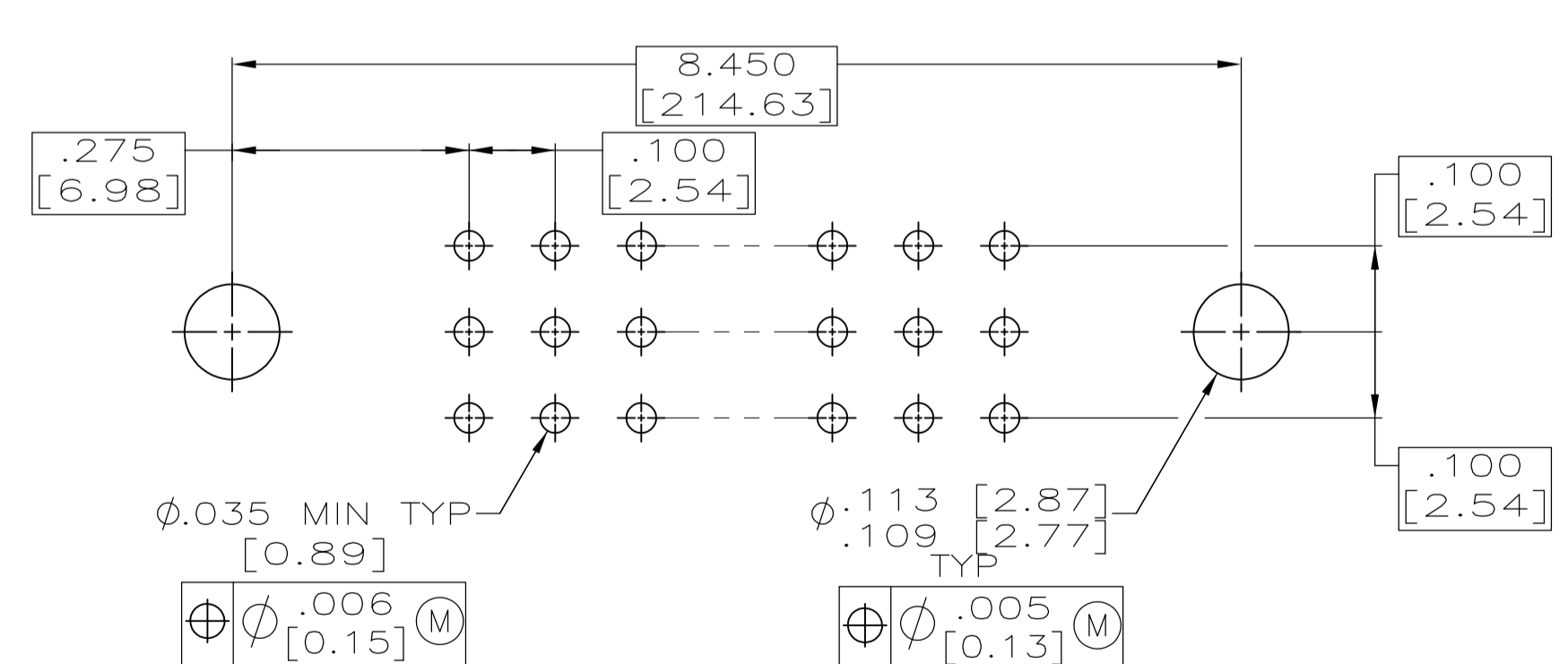

RECOMMENDED P. C. BOARD LAYOUT  
 WIRE WRAP TYPE

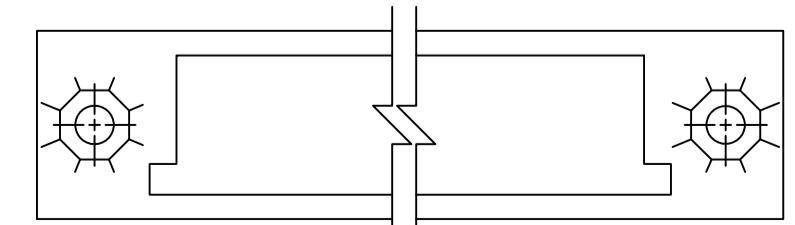

TYPE I

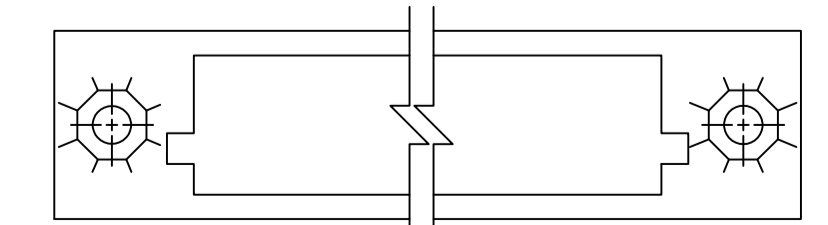

TYPE II

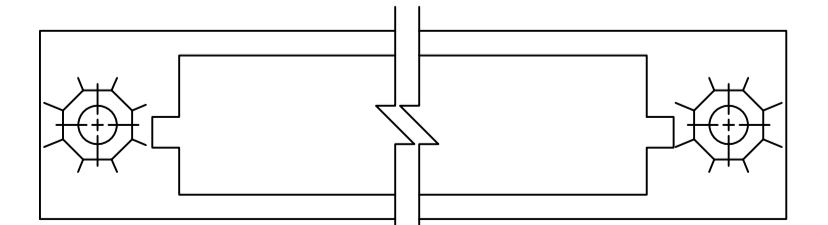

TYPE III

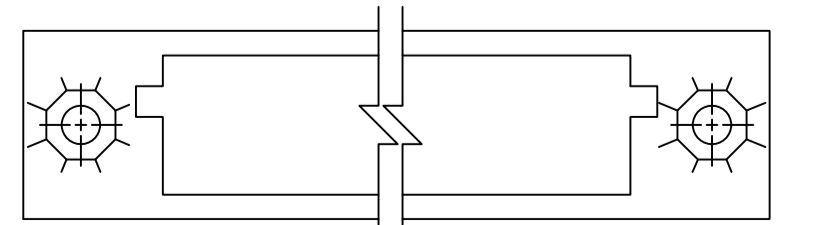

TYPE IV

- 1 MILITARY PART NUMBER, 00779, DATE CODE, PART NUMBER & AMP MARKED ON OPPOSITE SIDE.
- 2 HOUSING MATERIAL: POLYPHENYLENE SULFIDE.
- 3 CONTACT MATERIAL: BERYLLIUM COPPER (BeCu) OR COPPER-NICKEL-SILICON (CuNiSi).
- 4 CONTACT FINISH: .000050 GOLD IN CONTACT AREA, .000100 TIN-LEAD ON SOLDER TAILS, OVER .000030 NICKEL ENTIRE CONTACT.
- 5 P. C. BOARD MOUNTED CONNECTORS DO NOT REQUIRE STABILIZERS.
- 6 LINES INDICATING EVERY FIVE CAVITIES ON THIS SURFACE EXCEPT END CAVITIES, STARTING FROM POSITION 1.
- 7 NUMBERS INDICATING END CAVITIES ON THIS SURFACE .062±.010 HIGH CHARACTERS
- 8 KEYS (2) AND KEY MOUNTING HARDWARE (2) PACKAGED WITH CONNECTOR.
- 9 TESTING: GROUP A AND B PER MIL-C-55302.
- 10 LETTERS INDICATING OUTSIDE ROWS ON THIS SURFACE.
- 11 CONTACT FINISH: .000050 GOLD OVER .000030 NICKEL OVER ENTIRE CONTACT.
- 12 STABILIZER EPOXIED TO HOUSING.
- 13 EPOXY ADDED TO AREA WHERE THE CONTACT POSTS EMERGE FROM THE STABILIZER, SEE TABLE FOR APPLICABLE PART NUMBERS.

11 13	M55302/130-16	240	IV	240	1-447208-6
4	M55302/130-15	240	IV	240	1-447208-5
11 13	M55302/130-14	240	III	240	1-447208-4
4	M55302/130-13	240	III	240	1-447208-3
11 13	M55302/130-12	240	II	240	1-447208-2
4	M55302/130-11	240	II	240	1-447208-1
11 13	M55302/130-10	240	I	240	1-447208-0
4	M55302/130-09	240	I	240	447208-9
11	M55302/130-08	160	IV	240	447208-8
4	M55302/130-07	160	IV	240	447208-7
11 13	M55302/130-06	160	III	240	447208-6
4	M55302/130-05	160	III	240	447208-5
11 13	M55302/130-04	160	II	240	447208-4
4	M55302/130-03	160	II	240	447208-3
11	M55302/130-02	160	I	240	447208-2
4	M55302/130-01	160	I	240	447208-1
REMARKS	MILITARY PART NUMBER	NUMBER OF CONTACTS	TYPE	NUMBER OF POSITIONS	PART NUMBER

THIS DRAWING IS A CONTROLLED DOCUMENT.

DIMENSIONS: INCHES	TOLERANCES UNLESS OTHERWISE SPECIFIED:	DRAWING NO.	REV
0 PLC ± -	1 PLC ± -	5-4-90	1
2 PLC ± -	3 PLC ± .005 [0.13]	6-1-90	2
4 PLC ± -	ANGLES ± -		

STE TE Connectivity

RECEPTACLE ASSEMBLY, BOX, .100 C/L, W/KEYING HARDWARE

SIZE: A1 CASE CODE: 00779 DRAWING NO: 447208

CUSTOMER DRAWING SCALE: 5:1 SHEET: 1 OF 1 REV: G